

APP. TYPE	QTY
LX-200SG-07	1

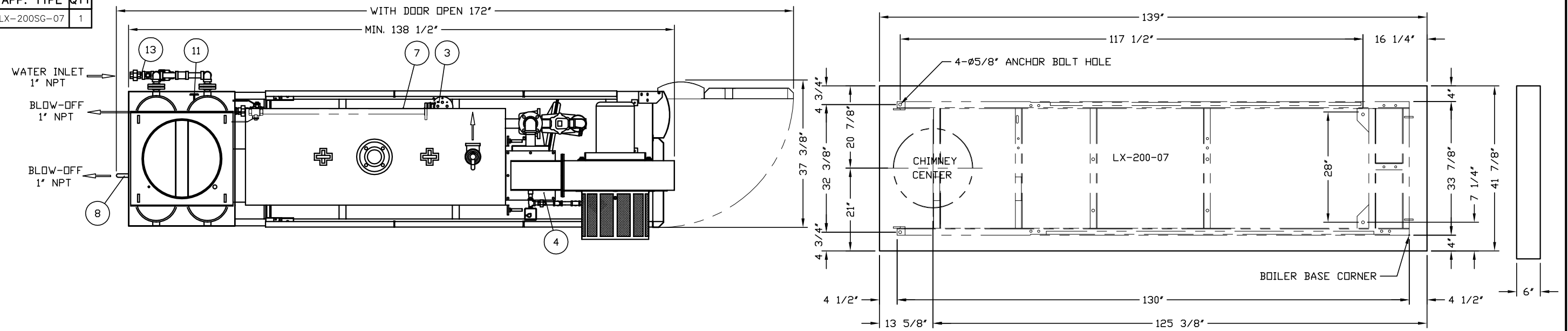

BOILER FOUNDATION

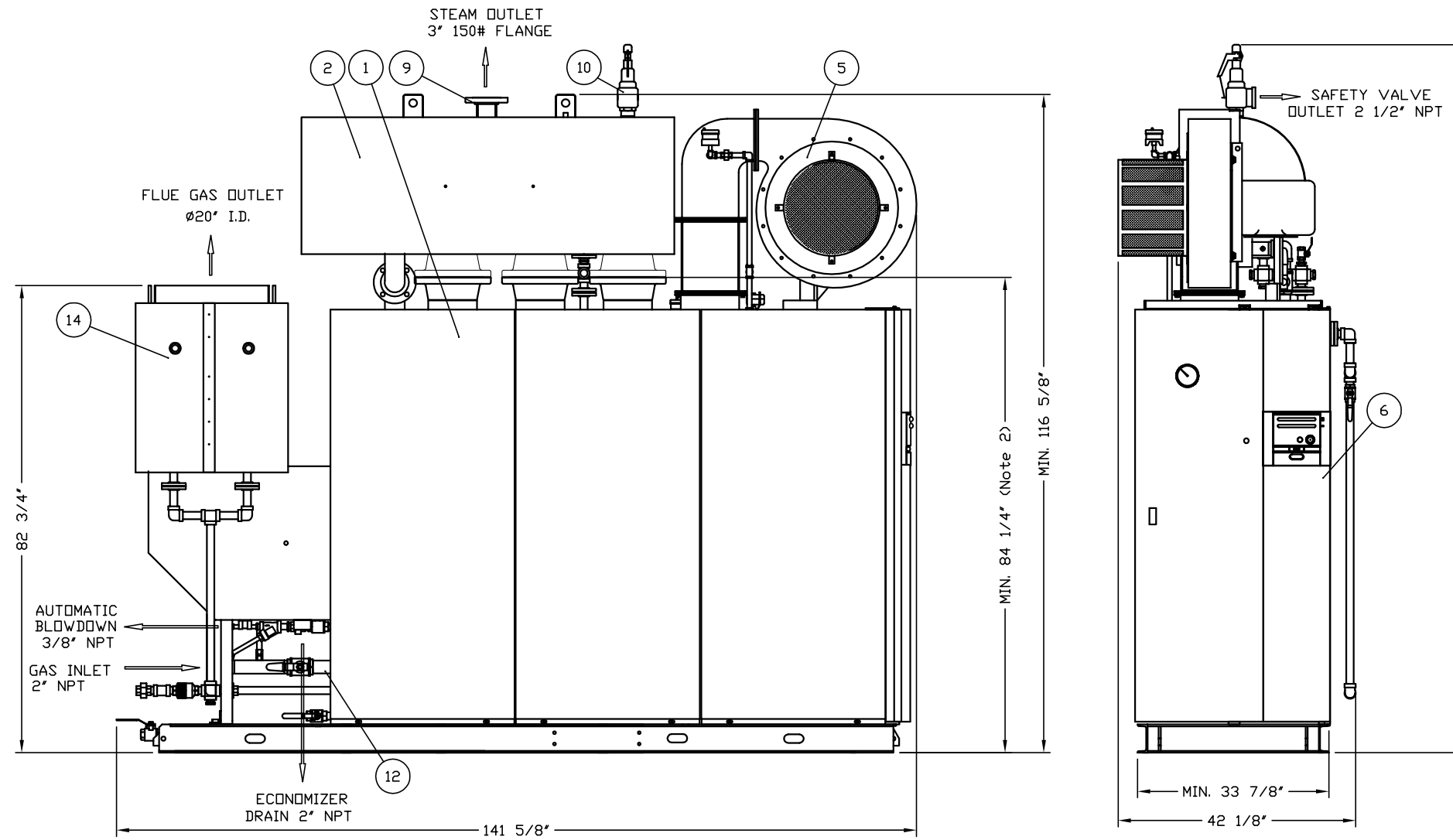

NOTE:

1. DIMENSIONS, SPECIFICATIONS AND SOME PIPINGS ARE SUBJECT TO CHANGE WITHOUT NOTICE.
- 2) MINIMUM HEIGHT WITH SEPARATOR & BLOWER ASSY DISMANTLED.

NO.	NAME OF PART	MATERIAL	QTY	REMARKS / DRAWING #
14	ECONOMIZER		1	ø20" I.D.
13	FEEDWATER PIPING		1	1"
12	MAIN GAS TRAIN		1	2"
11	AUTOMATIC BLOWDOWN		1	3/8"
10	MAIN SAFETY VALVE		1	2" x J x 2 1/2"
9	STEAM OUTLET		1	3"
8	MANUAL BLOW-OFF		1	1"
7	MANUAL BLOW-OFF		1	1"
6	CONTROL BOX		1	
5	BLOWER		1	
4	WIND BOX		1	
3	LIQUID VOLUME CONTROLLER		1	
2	STEAM SEPARATOR		1	
1	BOILER VESSEL		1	

DWN.: ALAN	CK'D.:	SCALE: NON	DO NOT SCALE
------------	--------	------------	--------------

" CONFIDENTIAL "

THIS MATERIAL IS THE PROPERTY OF MIURA BOILER CO., LTD., AND MUST NOT BE REPRODUCED, PUBLISHED OR DISCLOSED TO OTHERS WITHOUT AUTHORIZATION.

SYM	REVISION	DATE	BY	DATE: MAY.14,07	APPROVED:	THIRD ANGLE SYSTEM	DIM'N SHOWN ARE INCH
CAD DWG - NO MANUAL CHANGES PERMITTED				MIURA BOILER CO. LTD. BRANTFORD, ONTARIO, CANADA		DESCRIPTION: BOILER ASS'Y OUTSIDE VIEW	DRAWING NUMBER A000-LX20-OW53